

Lectures 17, 18, 19: Ethernet - 802.3 and 802.11

Brian Carpenter

314 S1T 2008

Ethernet (Shay 9.3)

- IEEE 802.3: CSMA/CD on a shared bus
 - 802.3 is the number of an IEEE standards committee (under the main 802 committee)

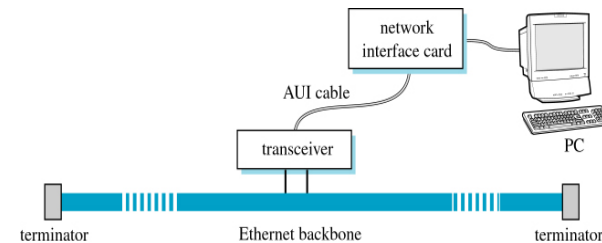

- Transceiver implements the MAC functions
- Originally 10 Mb/s on 50Ω coaxial cable with repeaters/bridges, later on UTP with hubs/switches

COMPSCI 314

2

Ethernet connection, step by step

- Sending host builds a frame, sends it to Network Interface Card (NIC)
- NIC adds an Ethernet Header, waits for medium idle
- Sends packet, transceiver watches for collision. Tells NIC whether transmission succeeded or failed, NIC retries using *exponential backoff* algorithm
- Receiving host's transceiver sees packet, copies it to its NIC
- That NIC checks packet by computing CRC. If it was for this host (only, or as part of group), sends it to host via interrupt handler

COMPSCI 314

3

Ethernet Frame, 802.2 encapsulation

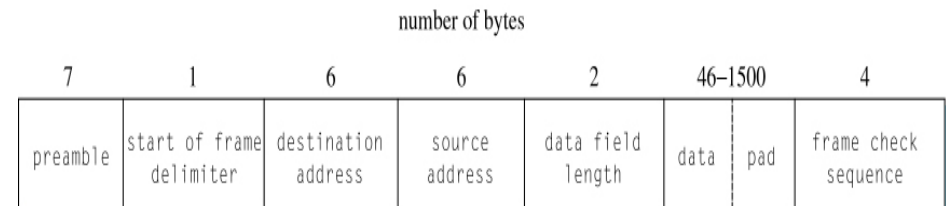

- SFD and FCS are not counted as 'packet' bytes – they're not passed in to the host
 - which is why Wireshark can't see them
- Data starts with an 802.2 header (if used)
- Addresses (6-byte) are globally unique, 48 bits (MAC-48), see next slide
- Ethernet sends bytes in ascending order, bits in a byte low-order-bit-first

COMPSCI 314

4

Ethernet Address Format (MAC-48)

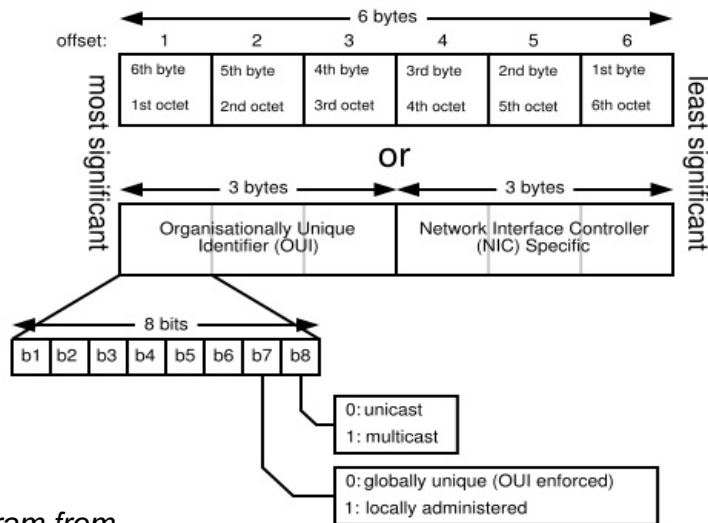

- Diagram from [Wikipedia](#) web page

COMPSCI 314

5

Looking at a real world address

Description: Broadcom NetXtreme 57xx Gigabit Controller

Physical Address: 00-1A-A0-4A-D6-80

OUI **specific**
 (manufacturer) (single device)

00 - 1A - A0
 0000 0000 0001 1010 1010 0000

**First bit
on wire**

**9th bit
on wire**

COMPSCI 314

6

Ethernet Frame, 'native'

- One extra convention*:
 - Data Length field can carry an Ethertype instead, provided that the Ethertype value is $> 1500_{10}$, Ethernet's maximum packet size.
 - For example, Ethertype 0x0800 = 2048 (IP)
 - Length ≤ 1500 means that an 802.2 header follows
 - (In other words, this is a trick to avoid having to use an 802.2 header)

* This comes from the original industry standard that preceded the official IEEE standard. It saves bits, so is widely used.

COMPSCI 314

7

'Native' frame format

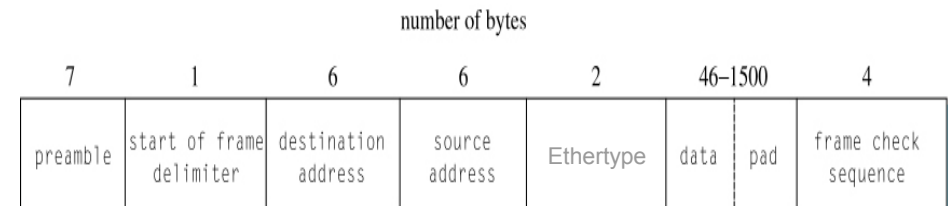

- How does the receiver know where the padding ends and the FCS starts?
 - there's no length field in the frame
 -

COMPSCI 314

8

Detecting Collisions

- Max packet size stops a host from monopolising the medium
- Min packet size set for reliable collision detection

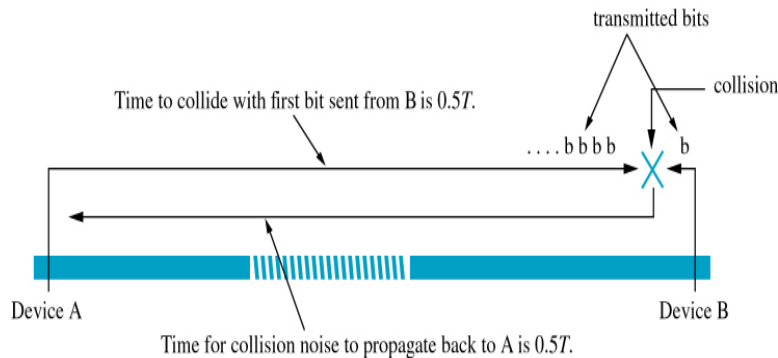

COMPSCI 314

9

10Base5 Ethernet Specifications

- 'Segment' = *collision domain*
- Max segment length **500m**
- Max of **four** repeaters joining segments
- $2500\text{m}/(2 \times 10^8) \text{ m/s} = 12.5 \mu\text{s}$, $25 \mu\text{s}$ round-trip
- Allow $25 \mu\text{s}$ for (worst-case) repeater delay
- $50 \mu\text{s}$ at $10 \text{ Mb/s} = 500 \text{ b}$, plus a few more
- $512 \text{ b} = 64 \text{ B}$
- Min inter-packet gap is **$12.5 \mu\text{s}$** (i.e. 2.5km of cable) for 10, 100 and 1000 Mb/s Ethernet

COMPSCI 314

10

Physical Implementations

- **10Base5** = Thick Wire
 - thick coax, vampire taps, AUI on (50m) AUI cable
- **10Base2** = Thin Wire
 - thin coax, tee connectors, AUI built into NIC
- **10BaseT** = UTP (unshielded twisted pair) wire
 - max UTP cable length 100 metres
 - UTP into hubs (multiport repeaters) or switches
 - no collisions in switches, allows full-duplex working
 - status pulse to verify link is connected (flashing *link light* on NIC) [see *Wikipedia* for details]

COMPSCI 314

11

Fast (100 Mb/s) Ethernet (Shay 9.4)

- 100BaseTX standardised (802.3u) in 1995
- Changes to go from 10 to 100 Mb/s on UTP:
 - couldn't use NRZI encoding directly at 100 Mb/s, too much RF interference (noise)
 - 4B/5B block encoding for each *nibble*, so as to ensure short 'same-bit' runs (Shay Table 9.3)
 - e.g. 1010-0010-0000-0000-0000-0000 becomes 10110-10100-11110-11110-11110-11110
 - that reduced the noise, but not enough to allow use of NRZI
 - MLT-3 signaling ..

COMPSCI 314

12

Fast (100 Mb/s) Ethernet (2)

- MLT-3 signaling, Multilevel Line Transmission – Three signal Levels

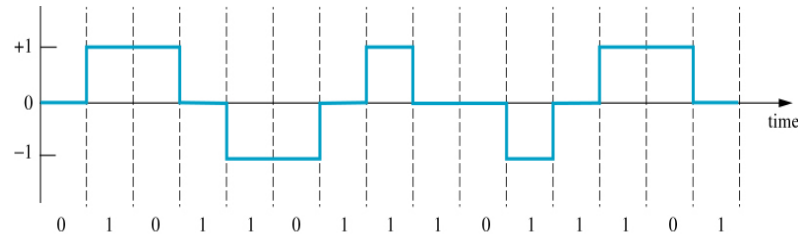

- MLT-3 cycles through -1, 0, 1, 0, -1, ...
 - for a 1 bit, progress to next state
 - for a 0 bit, maintain same state
- Uses 25% max frequency compared to Manchester, works well over UTP

Fast (100 Mb/s) Ethernet (3)

- 100BaseTX physical layers

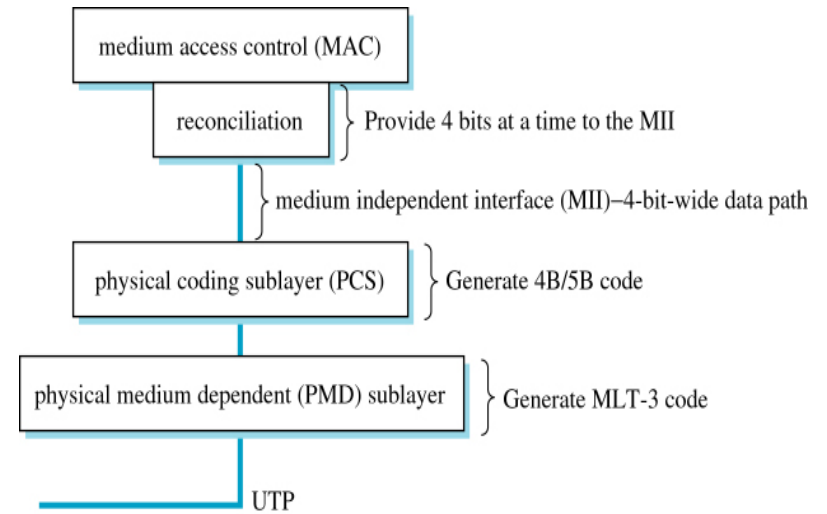

100BaseT4

- 100 Mb/s Ethernet on four Category 3 UTP cables
- Not widely used today

100BaseFX – 100 Mb/s on Fibre

- Multi-mode or single-mode fibre
- Segment length 412 metres if collisions can occur, 2 km in full duplex (i.e. using switches)
- Uses 4B/5B block encoding, same as for UTP
- Uses NRZI signaling instead of MLT-3
- Normally use ST fibre connectors
 - ST connectors just push in
 - SC (an older type) is a bayonet-style connector

Collision Domain

- 10Mb/s Ethernet used a minimum frame size of 512 bits, (transmitted in 51.2 μ s) for a maximum segment length of 2500m
- 100Mb/s Ethernet transmits a frame in 1/10 the time, so the max segment length decreases. For 100BaseTX it is only 100m
- 1GB/s Ethernet would require even less!

COMPSCI 314

17

Gigabit Ethernet (Shay 9.5)

- Collision Domains again ..
 - 1000BaseX (fibre, 802.3z) and 1000BaseT (twisted pair, 802.3ab) allow collisions
 - when collisions are possible, need to use a longer minimum frame so as to keep 100BaseTX's maximum segment length of 100m
 - do that by using a min frame of 4096 bits, i.e. extra padding on short packets
 - can also send a group of packets back-to-back as a 'burst frame,' only the first packet needs to be 4096 bits long
 - collisions are not possible in full-duplex mode; that uses 512b minimum frames (same as earlier standards)

COMPSCI 314

18

1000BaseX

- Gigabit Ethernet on fibre (or coax cable)
- Similar to 100Mb/s Ethernet, but uses GMII*
 - 8-bit-wide data path instead of 4
 - 1 bit of data (on all 8 lines) every 8 ns
- Uses 8B/10B block encoding instead of 4B/5B
 - code symbols are chosen so as to provide *DC balance*, i.e. equal numbers of 0s and 1 over the *long term*
 - has two encoder states and two alternate mappings for each symbol: 'more 0s' and 'more 1s'

*Gigabit Media Independent Interface

COMPSCI 314

19

1000BaseT

- Gigabit Ethernet over Category 5 UTP
 - Note: 1000BaseTX is a different standard [*not widely used, see Wikipedia*]
- Much harder for UTP than fibre because of its high signal frequencies
- Uses all four twisted pairs in Cat5 cable to carry 250 Mb/s each

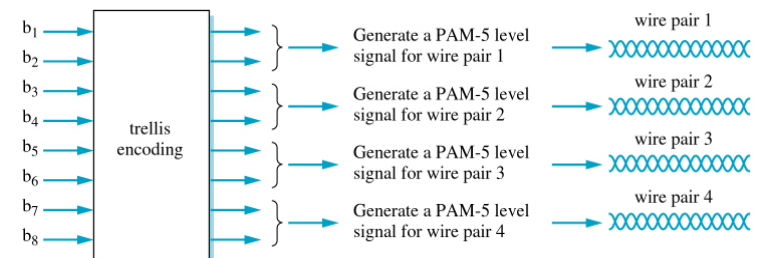

COMPSCI 314

20

1000BaseT (2)

- 1000BaseT does *not* support half-duplex
- Each GMII octet is divided into four 2-bit groups
- 5-level signalling – PAM5 – is used to send the 2-bit groups. Having 5 levels provides support for some control functions
- Cat5 isn't quite able to carry this reliably, so the link needs error-correction codes to allow for possible errors
 - *trellis encoding* sends extra information, *Viterbi decoding* detects and corrects errors
 - we're not going into the details!

COMPSCI 314

21

1000BaseT (3)

- All four Cat5 twisted pairs used for data
- Full-duplex carried over each pair at the same time using *hybrids* to combine/separate the signals

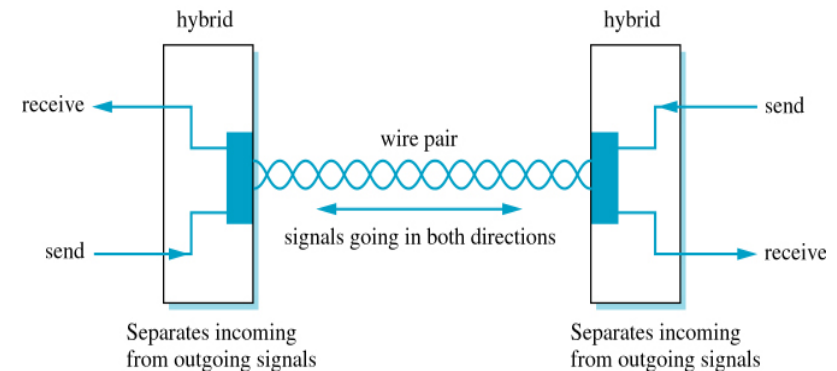

COMPSCI 314

22

10 Gb/s Ethernet

- 802.3ae only works in full-duplex on fibre
- Standard specifies two physical layer types
 - LAN-PHY – for use in LANs
 - e.g. 10GBaseLX4, 300m
 - WAN-PHY – for linking LANs over a wide area
 - e.g. 10GBaseER, 40km
 - an alternative to SONET or ATM

COMPSCI 314

23

Wireless Networks (Shay 9.7)

- 802.11 standard; link medium is radio or infrared
- Infrared can bounce off walls and ceiling, radio penetrates through walls
- Normally use one or more *access points* to provide connectivity to movable hosts

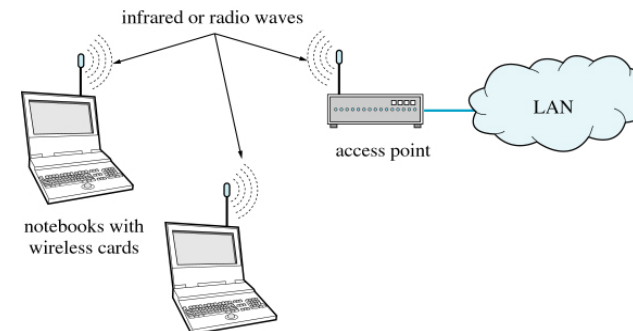

COMPSCI 314

24

The wireless family

- 802.11 refers to a family of standards for wireless networks, 802.11a, b etc.
- Often called WLAN (Wireless LAN). Sometimes carelessly called "Wireless Ethernet"
 - Different from Ethernet, but the programming model viewed from Layer 3 is like Ethernet
- Marketed as "Wi-Fi"
- 802.16 refers to a future family of broadband wireless standards marketed as "WiMax" or "WiBro"
- There are other standards (Bluetooth, Zigbee)

COMPSCI 314

25

Wireless basics

- Low power radio signals in 2.4 & 5 GHz bands
 - penetrate thin walls but bounce off concrete walls; effective range is tens of metres
 - 1 GigaHerz = 1000 MHz = one billion cycles/sec
- Infrared signals only work over a metre or so and any solid object blocks them
 - 802.11 over infrared is defined but really not very interesting...
- Bits can be modulated onto the radio wave using frequency modulation techniques
- The 2.4 GHz band is highly subject to interference (unregulated spectrum)
 - Many packets can be damaged in transit

COMPSCI 314

26

Spread Spectrum Wireless

- Used by 802.11 to minimise interference and (maybe) provide (a little) security
- Two technologies: Frequency Hopping (FHSS) and Direct-Sequence (DSSS)
- FHSS:
 - use a set of frequencies (channels)
 - hop between them in an agreed pseudo-random sequence
 - 802.11 uses 79 channels and 22 hopping sequences

COMPSCI 314

27

Spread Spectrum Wireless (2)

- DSSS (includes CDMA):
 - for each transmitted bit, send a *chip*, i.e. an n-bit pseudo-random sequence, as illustrated in this diagram

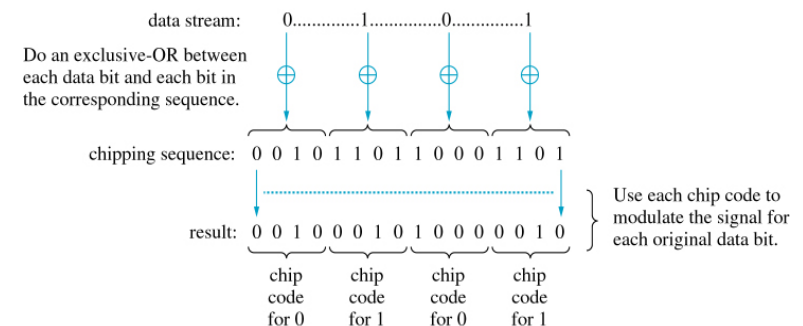

- effect is to generate a high-bandwidth signal, that signal is modulated onto a 2.4 Ghz carrier
- each station uses a different chipping sequence

COMPSCI 314

28

Collision avoidance

- Ethernet works by collision *detection* and retry
 - Drive out of the intersection, and get a new car if you crash
 - It's cheap to resend a packet
- 802.11 works by collision *avoidance*
 - Honk and listen before you drive out
 - Wireless transmission is expensive in battery-operated devices, so collision and retransmission is undesirable
 - A cheap radio can't detect collision anyway (its own signal drowns any incoming signal)
- CSMA/CA starts out like CSMA/CD
 - Wait until the channel is empty (no radio signal detected)
 - But then send a brief "I'm coming" signal and transmit if the channel stays empty

A better way to leave a stop sign



Contention, *Hidden Station* Problem

- Access Point (AP) can hear all stations, but they can't necessarily hear all of them
- That means they can't always detect a collision
- 802.11 has 'Distributed Coordination Function (DCF)' that implements CSMA/CA, i.e. Collision Avoidance even with hidden stations
- Next slide illustrates what happens when station A wants to send a message to station B ..

A hidden station interfering

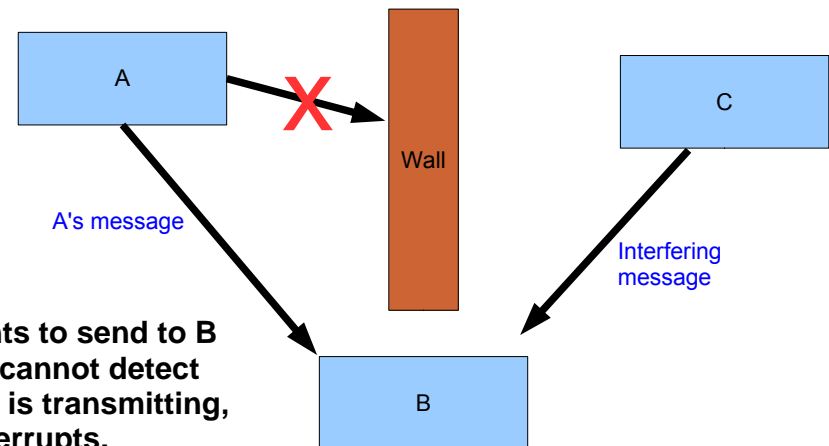

A wants to send to B but C cannot detect that A is transmitting, so interrupts.

Solution: A and B exchange short "request to send" and "clear to send" packets. C missed the RTS but hears the CTS and keeps quiet. (Optional and not found on cheaper equipment.)

CTS/RTS Protocol

- All devices are contending for the medium. A waits until medium not busy, waits DIFS seconds and sends RTS to B
- B receives RTS and responds with CTS back to A; *however*, it waits for SIFS seconds (a little less than DIFS) before sending. Any other host wanting to send an RTS will wait for DIFS seconds
- If two hosts send RTS at same time the RTS messages will probably collide at B, so B will sense the collision and won't send CTS
- When A receives CTS it knows it has the medium and can send data. When B receives the data it replies with ACK
- Transmission from A to B is now complete, all hosts go back to contending again

Topology choices

• Access Point (AP) or “infrastructure” mode

- AP also acts as management control point

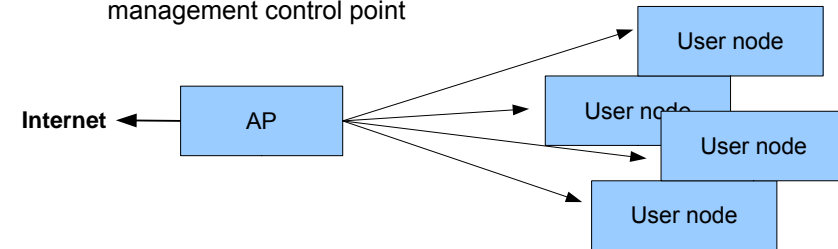

• Ad hoc mode (no AP)

- To be avoided – operational nightmare



More topology

- If A can see the AP but can't see B, the AP must relay packets
- Multiple AP's may be connected to form a single network – then packets must be relayed from one AP to another
- Several wireless networks may overlap – they are distinguished by a network identifier (SSID or (Basic) Service Set Identifier)
 - When a new device joins the network, it will do so by requesting the SSID announced by the AP
 - When the AP accepts the request, the device is said to be “associated” with the AP

Access point as a relay

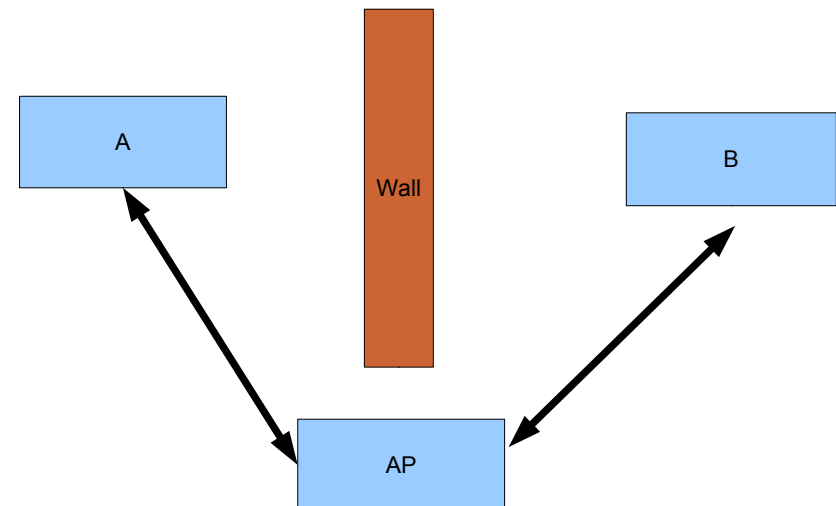

Indirect relay

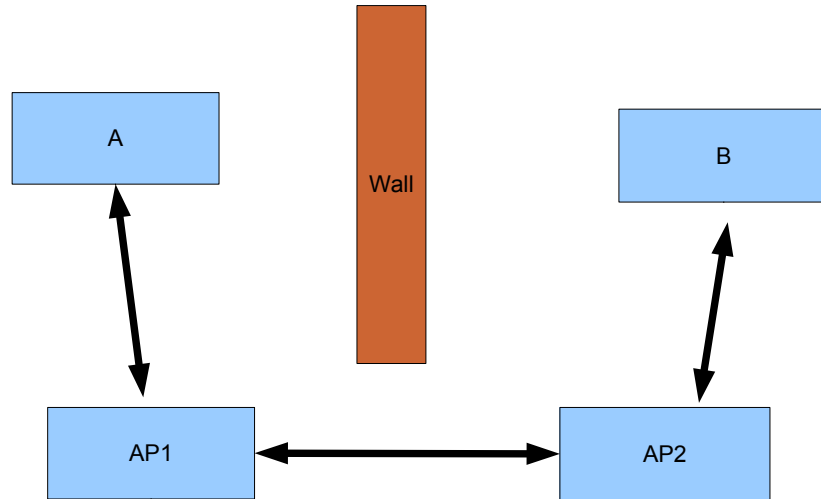

COMPSCI 314

37

Indirect relay via cabled LAN

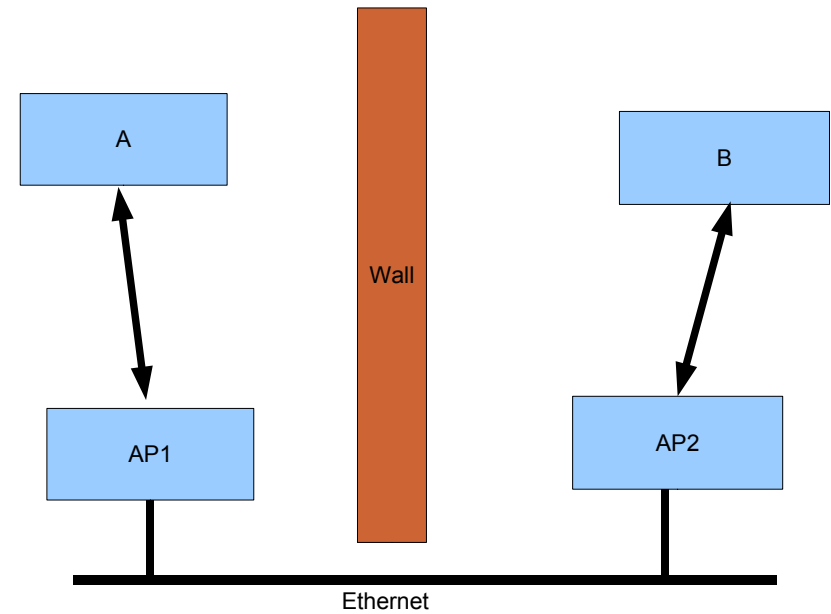

COMPSCI 314

38

A quick look at the roaming problem

A is talking to B* but suddenly walks over to A'

- restore wireless connection
- restore network connection
- resume session with B

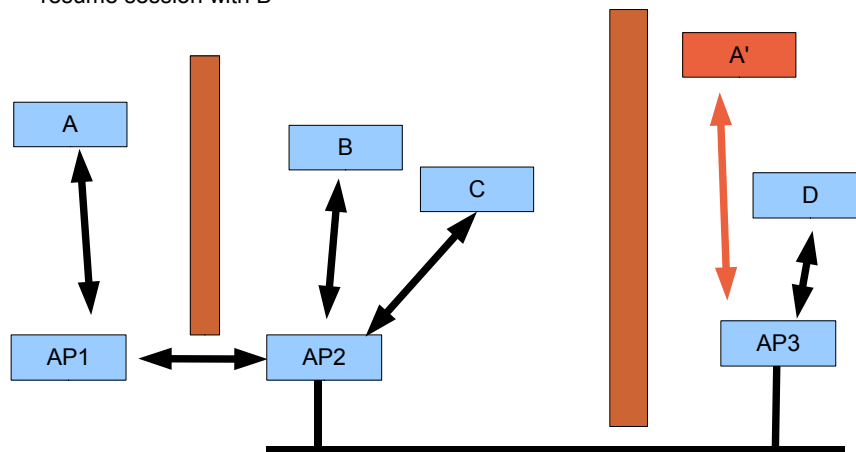

* B could also be elsewhere on the Internet; in fact that's more likely.

COMPSCI 314

39

802.11 Addressing

- All the stations that communicate with a single AP form a Basic Service Set (BSS) identified by SSID
- BSSes may be connected via a (wired) Distribution System (DS)
- Externally, addressing looks like Ethernet: packets are sent from a source address to a destination address.
- But to allow for AP relaying, 802.11 frames have *four* address fields selected from
 - Destination Address (DA)
 - Source Address (SA)
 - Sending Wireless Access Point address
 - Receiving Wireless Access Point address
 - wireless network identifier (SSID)
- Usage listed in Shay Table 9.9.

COMPSCI 314

40

802.11 Frame Format

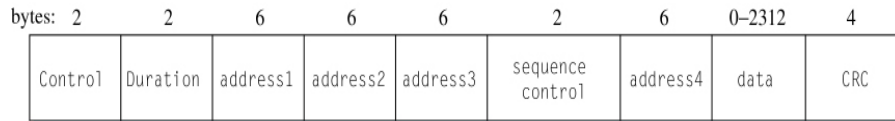

- Duration: time message will require (for RTS/CTS frames)
- Control: includes ..
 - More Fragments bit. 802.11 may decrease max frame size, fragmenting and reassembling frames as needed. That's done to increase probability of error-free communication
 - To/From DS bit. Set for frames to/from the Distribution System
 - frame Type field. Distinguishes data / control / management frames. RTS, CTS and ACK are control frames

802.11 Management Frames

- Used for:
 - configuring a BSS; *Associate* Request/Response
 - find an AP; *Probe* Req/Resp
 - roaming; *Reassociate* Req/Resp
 - security; *Authenticate* frame, for exchanging security information [keys?]

802.11 Security/Privacy

- Obviously, a wireless network can be received by anyone in the area, so security is needed except for public-access networks.
- WEP – Wired Equivalent Privacy - specified in 802.11
 - WEP is a simple authentication/encryption scheme using RC4, a 40-bit secret key and a 24-bit initialisation vector. Each message uses a different initialisation vector.
 - Supposedly it makes 802.11 as safe as an Ethernet cable.
 - True; both can be tapped! WEP was “broken” in 2001
 - WEP can be cracked because the initialisation vector sequence may repeat often if traffic is heavy, and 40 bits is a rather short key.

Fixing the WEP weakness

- Quick fix in 2003 known as WPA (Wi-Fi Protected Access), also based on RC4
- 802.11i (= WPA2) is a better solution using AES.
 - Key exchange preceded by 802.1X authentication
- But any wireless network, including Wi-Fi, is a security headache - so we need security in higher level protocols, above layer 2

Some variants of 802.11

- 802.11b
 - choice of channels in the 2.4 Ghz band
 - legal channels vary between countries
 - max data rate 11 Mb/s
- 802.11g
 - As 11b but max data rate 54 Mb/s
- 802.11a
 - choice of channels in the 5 Ghz band
 - legal channels vary between countries
 - less interference than b/g but covers less distance
 - max data rate 54 Mb/s
- 802.11n is coming

Hints for setting up a WLAN

- You don't *need* to broadcast your SSID (WLAN identifier), but the standard says you should.
- It's simple to configure an AP to recognise only a small set of 802.11 MAC addresses
 - but then your packets are not encrypted, so "Eve" can monitor them.
- WEP is better than nothing.
- WPA is better.
- WPA2 is even better.
- If you do none of these things, your neighbours *will* borrow your bandwidth.